

# Water Specialist CI Control Valve Programming and Cover Drawing Manual

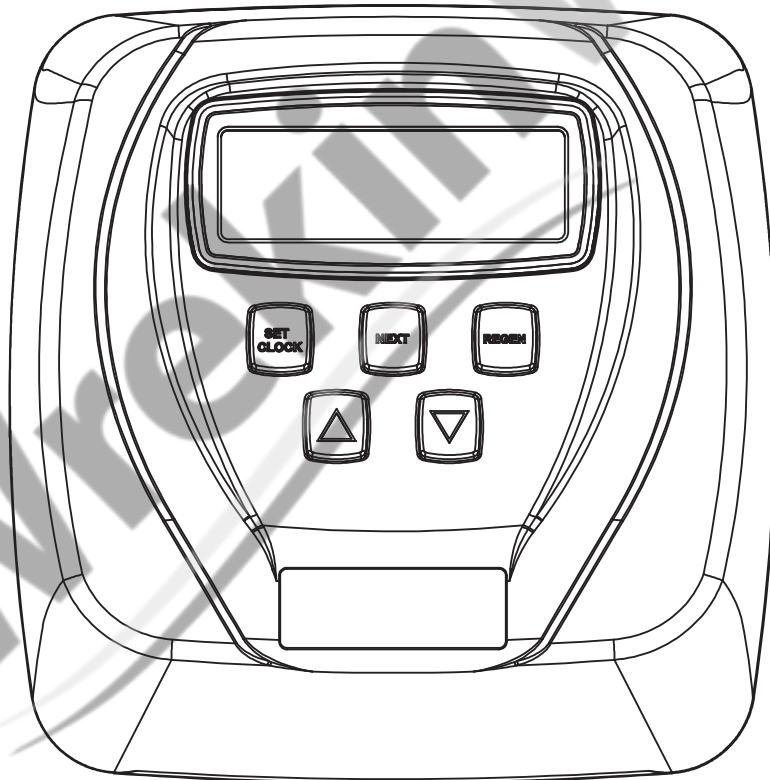

**Wrekin Water**

CI Front Cover and Drive Assembly

Drawing No.	Order No.	Description	Quantity
1	V3175CC-01	WS1CC FRONT COVER ASSEMBLY	1
2	V3107-01	WS1 MOTOR	1
3	V3106-01	WS1 DRIVE BRACKET & SPRING CLIP	1
4	V3108CI-02BOARD	WS1 THRU2L CI PCBRD ALT REPLACE	1
5	V3110	WS1 DRIVE REDUCING GEAR 12X36	3
6	V3109	WS1 DRIVE GEAR COVER	1
Not Shown	V3186	WS1 AC ADAPTER 110V-12V	1
	V3186EU	WS1 AC ADAPTER 220-240V-12V EU	
	V3186UK	WS1 AC ADAPTER 220-240V-12V UK	
	V3186-01	WS1 AC ADAPTER CORD ONLY	

AC Adapter	U.S.	International
Supply Voltage	120 V AC	230V AC
Supply Frequency	60 Hz	50 Hz
Output Voltage	12 V AC	12 V AC
Output Current	500 mA	500 mA

When replacing the battery, align positives and push down to fully seat.

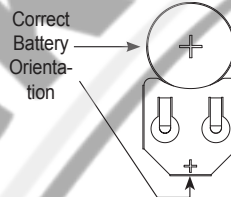
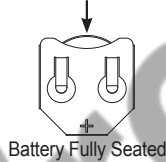

Battery replacement is 3 volt lithium coin cell type 2032.

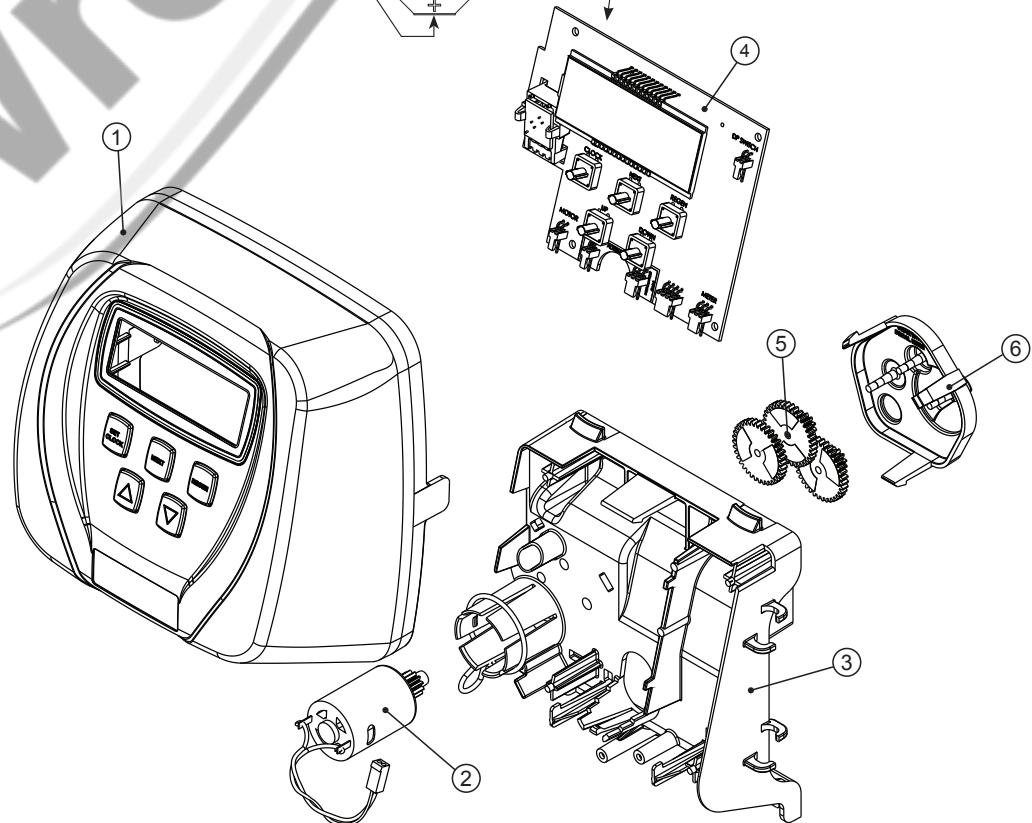

**Refer to Water Specialist 1.5” and 2L Control Valve Service Manual for the following Drawings and Part Numbers:**

- \*WS1.5 Drive Cap Assembly, Downflow Piston, Regenerant Piston, Spacer Stack Assembly, Main Body and Meter
- \*WS2L Drive Cap Assembly, Downflow Piston, Regenerant Piston, Spacer Stack Assembly and Main Body
- Meter Assembly for WS2L Valves
- Injector Cap, Injector Screen, Injector, Plug, Bolts and O-ring(s)
- Refill Flow Control Assembly and Refill Port Plug
- Drain Line  $\frac{3}{4}$ ”
- Drain Line 1”
- V3053 WS2 2-1/2 GROOVELOCK CLAMP ASY

\* The Drive Back Plate displayed on these drawings shows installation of one style of back plate. If a Drive Back Plate is needed order V3178 WS1 DRIVE BACK PLATE.

OEM General Instructions

The control valve offers multiple procedures that allow the valve to be modified to suit the needs of the installation. These procedures are:

- OEM Cycle Sequence
- OEM Softener System Setup
- OEM Filter System Setup
- Installer Display Settings
- User Display Settings
- Diagnostics
- Valve History

Once the OEM Cycle Sequence has been set, the other procedures can be accessed in any order. Details on each of the procedures are provided on the following pages.

To “lock out” access to diagnostic and valve history displays and modifications to settings except hardness, day override, time of regeneration and time of day by anyone but the manufacturer, press ▼, NEXT, ▲, and SET CLOCK in sequence after settings are made. To “unlock”, so other displays can be viewed and changes can be made, press ▼, NEXT, ▲, and SET CLOCK in sequence.

When in operation normal user displays such as time of day, volume remaining before regeneration, present flow rate or days remaining before regeneration are shown. When stepping through a procedure, if no buttons are pressed within five minutes, the display returns to a normal user display. Any changes made prior to the five minute time out are incorporated.

To quickly exit OEM Softener Setup, OEM Filter Setup, Installer Display Settings, Diagnostics or Valve History press SET CLOCK. Any changes made prior to the exit are incorporated.

**When desired, all information in Diagnostics may be reset to zero when the valve is installed in a new location. To reset to zero, press NEXT and ▼ buttons simultaneously to go to the Service/OEM 1 Screen. Press ▲ and ▼ simultaneously to reset diagnostic values to zero. Screen will return to User Display.**

Sometimes it is desirable to have the valve initiate and complete two regenerations within 24 hours and then return to the preset regeneration procedure. It is possible to do a double regeneration if the control valve is set to “NORMAL” or “NORMAL + on 0” in OEM Softener System Setup or OEM Filter System Setup. To do a double regeneration:

1. Press the “REGEN” button once. REGEN TODAY will flash on the display.
2. Press and hold the “REGEN” button for three seconds until the valve regeneration initiates.

Once the valve has completed the immediate regeneration, the valve will regenerate one more time at the preset regeneration time.

OEM Cycle Sequence

OEM Cycle Sequence instructions allows the OEM to set the order of the cycle. The OEM Softener System Setup or the OEM Filter System Setup allow the OEM to set how long cycles will last. The OEM may choose up to 9 cycles in any order.

Cycle Options			
BACKWASH	DN BRINE	FILL	END
RINSE	UP BRINE (WS1 Only)	SOFTENING OR FILTERING	

END must be used as the last cycle option. The SERVICE cycle should only be used in brine prefill applications.

The upflow cycle may not be used on the WS1.25, WS1.5 or WS2L control valves, because the V3407 piston is designed for downflow use only. For WS1 valves, prior to selecting DN brine or UP brine or not selecting a regenerant flow cycle, verify the correct valve body, main piston, regenerant piston, and stack are being used, and that the injector or injector plug(s) are in the correct locations. See Valve Body Compliance Table in WS1 & WS1.25 OEM General Information Manual.

The following is an example of how to set a valve so that when regeneration is initiated BACKWASH occurs first, dn BRINE occurs second, RINSE occurs third, and FILL occurs fourth.

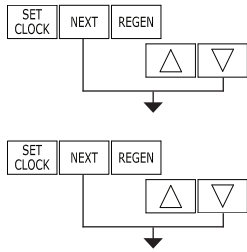
**STEP 1CS**

**Step 1CS** – Press NEXT and ▼ simultaneously for 3 seconds and release. Then press NEXT and ▼ simultaneously for 3 seconds and release. If screen in Step 2CS does not appear in 5 seconds the lock on the valve is activated. To unlock press ▼, NEXT, ▲, and SET CLOCK in sequence, then press NEXT and ▼ simultaneously for 3 seconds and release.

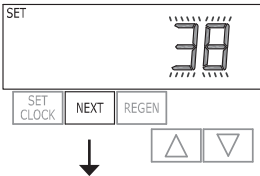
**STEP 2CS**

**Step 2CS** – Use the ▲ or ▼ to select 25 for WS1 valve, 32 for WS1.25 valve, 38 for WS1.5 valve or 50 for WS2L valve. Press NEXT to go to Step 3CS. Press REGEN to exit OEM cycle sequence.

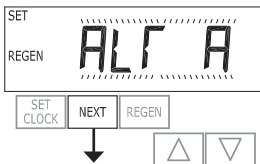
**STEP 3CS**

**Step 3CS** – Allows selection of one of the following using the ▲ or ▼ buttons:

- the Control Valve to act as an alternator; or
- the Control Valve to have no hard water bypass.

Selecting the Control Valve to act as an alternator:

Note: Also must do one of the following:

- If set up for a softener, in Step 5CS select -nA-; in Step 7S, set Volume Capacity in M<sup>3</sup>; in Step 8S select “norES”, in Step 9S select Regeneration Time Option “on 0”; and in Step 4I select Day Override “oFF”.
- If set up for a filter, in Step 7F set Volume Capacity in M<sup>3</sup>; in Step 8F select Regeneration Time Option “on 0”; and in Step 4I select Day Override “oFF”.

Select OFF when feature is not used.

Select ALTA for the control valve that has the two pin connector labeled DRIVE connected to the alternator valve motor.

Select ALTb for the control valve that will not be connected to the alternator valve motor.

Configuring the Control Valve for No Hard Water Bypass Operation:

Select nHbP for control operation with a no hard water bypass valve.

Selection requires that a connection to a Clack Motorized Alternator Valve (MAV) is made to the two pin connector labeled ALTERNATOR DRIVE located on the printed circuit board. The B port of the MAV must be plugged and the valve outlet connected to the A port. The MAV will be driven closed before the first regeneration cycle that is not FILL or SOFTENING or FILTERING, and be driven open after the last regeneration cycle that is not FILL.

Press NEXT to go to Step 4CS. Press REGEN to return to previous step.

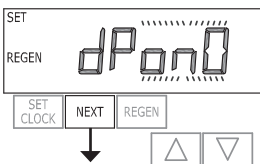
**STEP 4CS**

**Step 4CS** – Allows selection of one of the following using the ▲ or ▼ buttons:

- an outside signal to initiate a regeneration;
- an outside signal to prevent or delay regeneration.

Selection only matters if a connection is made to the two pin connector labeled DP SWITCH located on the printed circuit board. Following is an explanation of the options:

OFF - Feature not used.

dPon0 - If the dP switch is closed for an accumulative time of 2 minutes a regeneration will occur immediately.

dPdEL - If the dP switch is closed for an accumulative time of 2 minutes a regeneration will occur at the scheduled regeneration time.

HoLd - If the dP switch is closed a regeneration will be prevented from occurring.

Press NEXT to go to Step 5CS. Press REGEN to return to previous step.

**STEP 5CS**

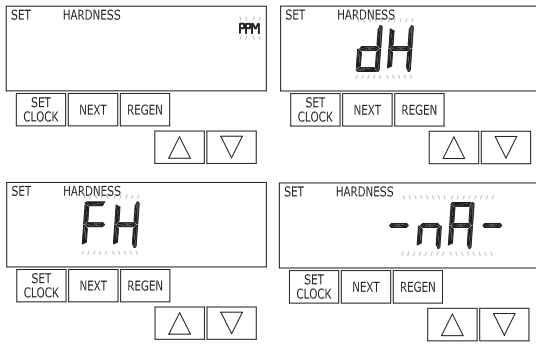

**Step 5CS** – Determine the measurement to calculate volumetric capacity. The choices are:

- ppm** parts per million
- FH** French degrees
- dH** German degrees

**-nA-** Using -nA- will allow the OEM to directly place the volume of water treated in place of system capacity in the OEM Softener System Setup level.  
**NOTE:** If control is going to be used in a filter application any of these settings can be used.

Press NEXT to go to Step 6CS. Press REGEN to return to previous step.

**STEP 6CS**

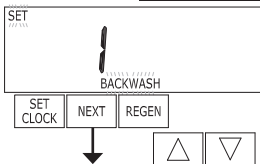

**Step 6CS** – Press the ▼ or ▲ buttons until BACKWASH appears. Press NEXT to go to Step 7CS. Press REGEN to return to previous step.

**STEP 7CS**

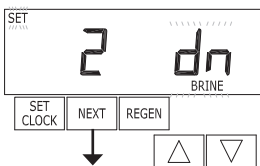

**Step 7CS** - Press the ▼ or ▲ buttons until dn BRINE appears. Press NEXT to go to Step 8CS. Press REGEN to return to previous step. For a WS1 control valve; prior to selecting a regenerant flow cycle, verify the correct valve body, main piston, regenerant piston and stack are being used, and the injector or injector plug(s) are in the correct location. Refer to WS1 & WS1.25 Common Information manual, Valve Body Compliance Table.

**STEP 8CS**

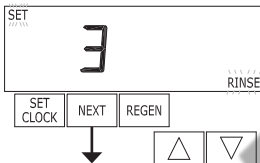

**Step 8CS** - Press the ▼ or ▲ buttons until RINSE appears. Press NEXT to go to Step 9CS. Press REGEN to return to previous step.

**STEP 9CS**

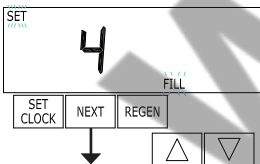

**Step 9CS** - Press the ▼ or ▲ buttons until FILL appears. Press NEXT to go to Step 10CS. Press REGEN to return to previous step.

**STEP 10CS**

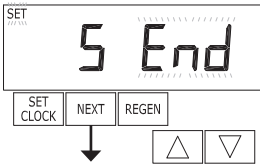

**Step 10CS** - Press the ▼ or ▲ buttons until END appears. Press NEXT to exit OEM Cycle Sequence. Press REGEN to return to previous step.

RETURN TO NORMAL MODE

### OEM Softener System Setup

In OEM Softener System Setup the OEM chooses the time for the cycles selected in OEM Cycle Sequence and specifies other operating parameters for the system. The upper and lower limits of the allowable values for the cycles are as follows:

Cycle Options	Units	Lower/Upper Limit
Backwash	Minutes	1 to 120
Rinse (fast)	Minutes	1 to 120
dn Brine (combination of brining and slow rinse)	Minutes	1 to 180
up Brine (combination of brining and slow rinse)	Minutes	1 to 180
Fill	Kg	0.05 to 90.00
Service	Minutes	1 to 480

Note: Fill is in Kilograms of salt.

Since no time is associated with the END cycle, the END cycle will not appear in the OEM Softener System Setup sequence.

**STEP 1S**

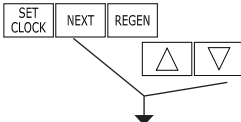

**Step 1S** – Press NEXT and ▼ simultaneously for 3 seconds and release. If screen in Step 2S does not appear in 5 seconds the lock on the valve is activated. To unlock press ▼, NEXT, ▲, and SET CLOCK in sequence, then press NEXT and ▼ simultaneously for 3 seconds and release.

**STEP 2S**

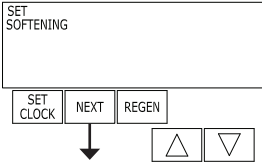

**Step 2S** – Choose SOFTENING using the ▼ or ▲ button. Press NEXT to go to Step 3S. Press REGEN to exit OEM Softener System Setup.

**STEP 3S**

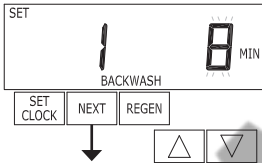

**Step 3S** – Select the time for the first cycle (which in this example is BACKWASH) using the ▼ or ▲ button. Press NEXT to go to Step 4S. Press REGEN to return to previous step.

**STEP 4S**

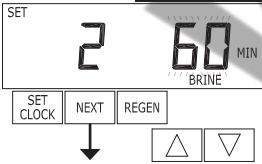

**Step 4S** – Select the time for the second cycle (which in this example is dn BRINE) using the ▼ or ▲ button. Press NEXT to go to Step 5S. Press REGEN to return to previous step.  
NOTE: The display will flash between cycle number and time, and brine direction (dn).

**STEP 5S**

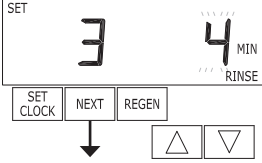

**Step 5S** – Select the time for the third cycle (which in this example is RINSE) using the ▼ or ▲ button. Press NEXT to go to Step 6S. Press REGEN to return to previous step.

**STEP 6S**

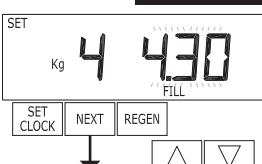

**Step 6S** – Select the Kg for the fourth cycle (which in this example is FILL) using the ▼ or ▲ button. Press NEXT to go to Step 7S. Press REGEN to return to previous step.



**STEP 7S**

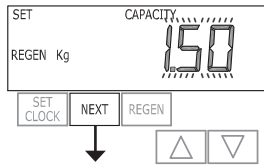

**Step 7S** – Set System Capacity using the ▼ or ▲ button. See chart. The System Capacity setting should be based on the volume of resin and Kg of salt fill set in Step 6S. When using ppm, dH, or FH the system capacity and hardness levels entered are used to determine the Volume Capacity. Press NEXT to go to Step 8S. Press REGEN to return to previous step.

Setting	Units	Limits
PPM	Kg of CaCO <sub>3</sub>	0.10 - 200
nA	M <sup>3</sup>	0.10 - 2000
dH or FH	H*M <sup>3</sup>	1 - 6000

**STEP 8S**

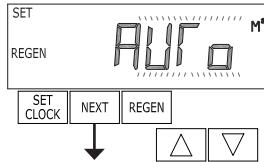

**Step 8S** – Set Volume Capacity using the ▼ or ▲ button. If value is set to:

- “AUTO” capacity will be automatically calculated and reserve capacity will be automatically estimated;
- “oFF” regeneration will be based solely on the day override set (see Installer Display/Settings Step 4I); or
- a number, regeneration initiation will be based on the value specified (in M<sup>3</sup>).
- “norES” for no reserve operations, if -nA- was selected in Step 5CS.

If “oFF” or a number is used, hardness display will not be allowed to be set in Installer Display Settings Step 2I&3I. See Setting Options Table for more detail. Press NEXT to go to Step 9S. Press REGEN to return to previous step.

**STEP 9S**

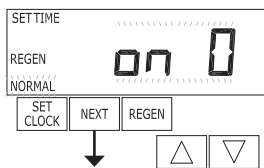

**Step 9S** – Set Regeneration Time Options using the ▼ or ▲ button. If value is set to:

- “NORMAL” means regeneration will occur at the preset time;
- “on O” means regeneration will occur immediately when the volume capacity reaches 0 (zero); or
- “NORMAL + on O” means regeneration will occur at one of the following:
  - the preset time when the volume capacity falls below the reserve or the specified number of days between regenerations is reached whichever comes first; or
  - immediately after 10 minutes of no water usage when the volume capacity reaches 0 (zero).

See Setting Options Table for more detail. Press NEXT to go to Step 10S. Press REGEN to return to previous step.

**STEP 10S**

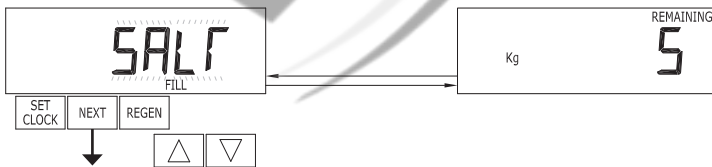

RETURN TO NORMAL MODE

**Step 10S** – Set Low Salt Warning using the ▼ or ▲ button. If value is set to:

- “oFF” no low salt level warning will appear for the user; or
- a specific value, “FILL SALT” will flash on the display when the calculated remaining Kg of salt falls below that level. Allowable values range from 5 to 200 Kg in 5 Kg increments.

Press NEXT to exit OEM Softener System Setup. Press REGEN to return to previous step.

## Setting Options Table

Filters should only use shaded options

Volume Capacity	Regeneration Time Option	Day Override	Result <sup>1</sup>
AUTO	NORMAL	oFF	Reserve capacity automatically estimated. Regeneration occurs when volume capacity falls below the reserve capacity at the next Regen Set Time
AUTO	NORMAL	Any number	Reserve capacity automatically estimated. Regeneration occurs at the next Regen Set Time when volume capacity falls below the reserve capacity or the specified number of days between regenerations is reached.
Any number	NORMAL	oFF	Reserve capacity <u>not</u> automatically estimated. Regeneration occurs at the next Regen Set Time when volume capacity reaches 0.
oFF	NORMAL	Any number	Reserve capacity <u>not</u> automatically estimated. Regeneration occurs at the next Regen Set Time when the specified number of days between regenerations is reached.
Any number	NORMAL	Any number	Reserve capacity <u>not</u> automatically estimated. Regeneration occurs at the next Regen Set Time when volume capacity reaches 0 or the specified number of days between regenerations is reached.
AUTO	On 0	oFF	Reserve capacity <u>not</u> automatically estimated. Regeneration occurs immediately when volume capacity reaches 0. Time of regeneration will not be allowed to be set because regeneration will always occur when volume capacity reaches 0.
Any number	On 0	oFF	Reserve capacity <u>not</u> automatically estimated. Regeneration occurs immediately when volume capacity reaches 0. Time of regeneration will not be allowed to be set because regeneration will always occur on 0.
AUTO	NORMAL on 0	oFF	Reserve capacity automatically estimated. Regeneration occurs when volume capacity falls below the reserve capacity at the next Regen Set Time or regeneration occurs after 10 minutes of no water usage when volume capacity reaches 0.
AUTO	NORMAL on 0	Any number	Reserve capacity automatically estimated. Regeneration occurs at the next Regen Set Time when volume capacity falls below the reserve capacity or the specified number of days between regenerations is reached or regeneration occurs after 10 minutes of no water usage when volume capacity reaches 0.
Any number	NORMAL on 0	Any number	Reserve capacity <u>not</u> automatically estimated. Regeneration occurs at the next Regen Set Time when the specified number of days between regenerations is reached or regeneration occurs after 10 minutes of no water usage when volume capacity reaches 0.

<sup>1</sup> Reserve capacity estimate is based on history of water usage

OEM Filter System Setup

In OEM Filter System Setup the OEM chooses the time for the cycles selected in OEM Cycle Sequence and specifies other operating parameters for the system. The upper and lower limits of the allowable values for the cycles are as follows:

Cycle Options	Units	Lower/Upper Limit
Backwash	Minutes	1 to 120
Rinse (fast)	Minutes	1 to 120
dn Brine (combination of regenerant and slow rinse)	Minutes	1 to 180
up Brine (combination of regenerant and slow rinse)	Minutes	1 to 180
Fill	Liters	0.05 to 76.00
Service	Minutes	1 to 480

NOTE: Fill is in liters.

Since no time is associated with the END cycle, the END cycle will not appear in the OEM Filter System Setup sequence.

**STEP 1F** Step 1F – Press NEXT and ▼ simultaneously for 3 seconds and release. If screen in Step 2F does not appear in 5 seconds the lock on the valve is activated. To unlock press ▼, NEXT, ▲, and SET CLOCK in sequence, then press NEXT and ▼ simultaneously for 3 seconds and release.

**STEP 2F** Step 2F – Choose FILTERING using the ▼ or ▲ buttons. Press NEXT to go to Step 3F. Press REGEN to exit OEM Filter System Setup.

**STEP 3F** Step 3F – Select the time for the first cycle (which in this example is BACKWASH) using the ▼ or ▲ button. Press NEXT to go to Step 4F. Press REGEN to return to previous step.

**STEP 4F** Step 4F – Select the time for the second cycle (which in this example is dn BRINE) using the ▼ or ▲ button. Press NEXT to go to Step 5F. Press REGEN to return to previous step. NOTE: The display will flash between cycle number and time, and brine direction (dn Brine).

**STEP 5F** Step 5F – Select the time for the third cycle (which in this example is RINSE) using the ▼ or ▲ button. Press NEXT to go to Step 6F. Press REGEN to return to previous step.

**STEP 6F** Step 6F – Select the volume in liters for the fourth cycle (which in this example is FILL) using the ▼ or ▲ button. Press NEXT to go to Step 7F. Press REGEN to return to previous step.

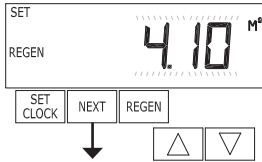
**STEP 7F**

**Step 7F** – Set Volume Capacity using the ▼ or ▲ button. If value is set to:

- “oFF” regeneration will be based solely on the day override set (see Installer Display/Settings Step 4I); or
  - a number, regeneration initiation will be based off the value specified (in M<sup>3</sup>).
- See Setting Options Table for more detail. Press NEXT to go to Step 8F. Press REGEN to return to previous step.

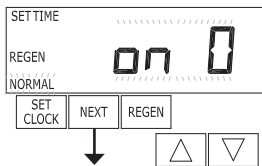
**STEP 8F**

RETURN TO NORMAL MODE

**Step 8F** – Set Regeneration Time Options using the ▼ or ▲ button. If value is set to:

- “NORMAL” means regeneration will occur at the preset time;
  - “on 0” means regeneration will occur immediately when the volume capacity reaches 0 (zero); or
  - “NORMAL + on 0” means regeneration will occur at one of the following:
    - the preset time when the volume capacity falls below the reserve or the specified number of days between regenerations is reached whichever comes first;
    - or
    - immediately after 10 minutes of no water usage when the volume capacity reaches 0 (zero).
- See Setting Options Table for more detail. Press NEXT to exit OEM Filter System Setup. Press REGEN to return to previous step.

Installer Display Settings

**STEP 1I**

**STEP 1I** - Press NEXT and ▲ simultaneously for 3 seconds.

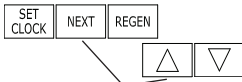

**STEP 2I**

**STEP 2I** – Hardness: Set the amount of influent hardness using the ▼ or ▲ buttons. This display will show “-nA-” if “FILTER” is selected in Step 2F OR if “-nA-” was selected in Step 5CS OR if “oFF” or a number was selected in Step 8S. Press NEXT to go to step 3I. Press REGEN to exit Installer Display Settings.

Units	Allowable Range	Allowable range may vary depending on system capacity selected.
PPM	1-2500	
FH	1-250	
dH	1-150	



**STEP 3I**

**STEP 3I** – Hardness 2: If using a mixing valve, set the amount of effluent hardness using the ▼ or ▲ buttons. Range of available values may vary depending on system capacity selected and hardness selected in Step 2I. This display will show “-nA-” if “FILTER” is selected in Step 2F OR if -nA- was selected in Step 5CS OR “oFF” or a number was selected in Step 8S. Press NEXT to go to Step 4I. Press REGEN to return to previous step.



**STEP 4I**

**STEP 4I** – Day Override: When volume capacity is set to “oFF”, sets the number of days between regenerations. When volume capacity is set to AUTO or to a number, sets the maximum number of days between regenerations. If value set to “oFF”, regeneration initiation is based solely on volume used. If value is set as a number (allowable range from 1 to 28) a regeneration initiation will be called for on that day even if sufficient volume of water were not used to call for a regeneration. Set Day Override using ▼ or ▲ buttons:

- number of days between regeneration (1 to 28); or
- “oFF”.

See Setting Options Table for more detail on setup. Press NEXT to go to step 5I. Press REGEN to return to previous step.



**STEP 5I**

**STEP 5I** – Next Regeneration Time (hour): Set the hour of day for regeneration using ▼ or ▲ buttons. The default time is 2:00. This display will show “REGEN on 0 L” if “on 0” is selected in Set Regeneration Time Option in OEM Softener System Setup or OEM Filter System Setup. Press NEXT to go to step 6I. Press REGEN to return to previous step.



**STEP 6I**

**STEP 6I** – Next Regeneration Time (minutes): Set the minutes of day for regeneration using ▼ or ▲ buttons. This display will not be shown if “on 0” is selected in Set Regeneration Time Option in OEM Softener System Setup or OEM Filter System Setup. Press NEXT to exit Installer Display Settings. Press REGEN to return to previous step.



RETURN TO NORMAL MODE

To initiate a manual regeneration immediately, press and hold the “REGEN” button for three seconds. The system will begin to regenerate immediately. The control valve may be stepped through the various regeneration cycles by pressing the “REGEN” button.

## User Display Settings

### General Operation

When the system is operating, one of five displays may be shown. Pressing NEXT will alternate between the displays. One of the displays is always the current time of day. The second display is one of the following: days remaining or volume remaining. Days remaining is the number of days left before the system goes through a regeneration cycle. Capacity remaining is the cubic meters that will be treated before the system goes through a regeneration cycle. The third display shows the current treated water flow rate through the system. The fourth display will show either dP or hold if the dP switch is closed. The fifth display shows the Kg of salt remaining or flashes "SALT" fill when the calculated Kg of salt falls below a safety level. The fifth display will not appear if the valve is set up as a filter or if the Set Low Salt Warning is set to off (see last step in OEM Softener System Setup). The user can scroll between the displays as desired. If the system has called for a regeneration that will occur at the preset time of regeneration, the words REGEN TODAY will appear on the display. If a water meter is installed, the word "Softening" or "Filtering" flashes on the display when water is being treated (i.e. water is flowing through the system).

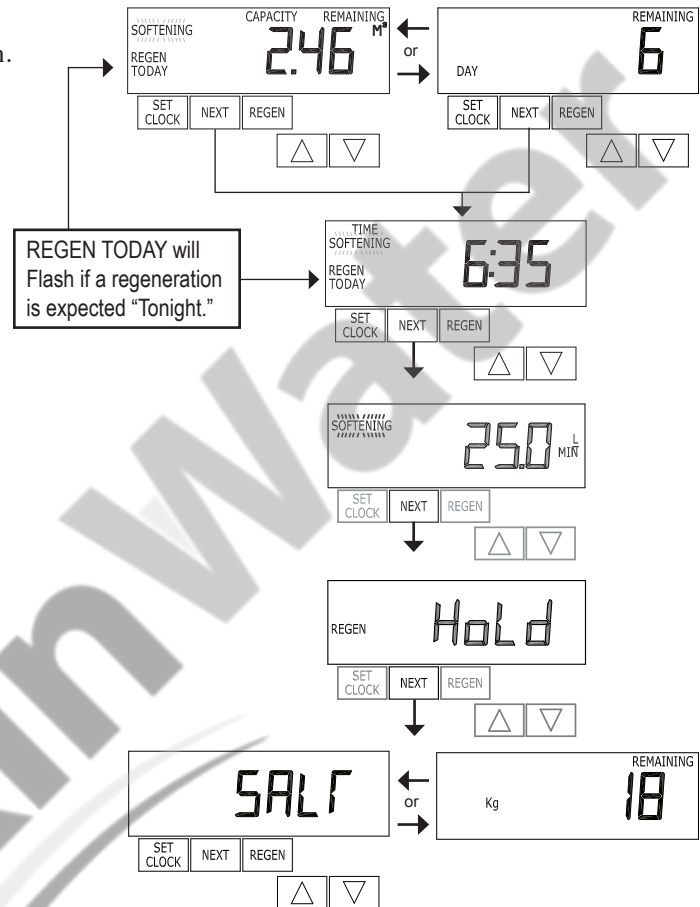

### Regeneration Mode

Typically a system is set to regenerate at a time of low water usage. An example of a time with low water usage is when a household is asleep. If there is a demand for water when the system is regenerating, untreated water will be used.



When the system begins to regenerate, the display will change to include information about the step of the regeneration process and the time remaining for that step to be completed. The system runs through the steps automatically and will reset itself to provide treated water when the regeneration has been completed.

### Manual Regeneration

Sometimes there is a need to regenerate the system sooner than when the system calls for it, usually referred to as manual regeneration. There may be a period of heavy water usage because of guests or a heavy laundry day.

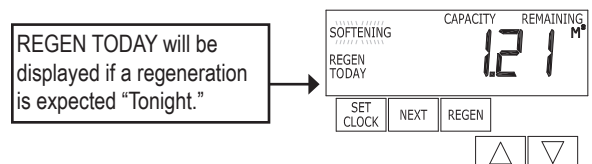

To initiate a manual regeneration at the preset delayed regeneration time, when the regeneration time option is set to "NORMAL" or "NORMAL + on 0", press and release "REGEN". The words "REGEN TODAY" will flash on the display to indicate that the system will regenerate at the preset delayed regeneration time. If you pressed the "REGEN" button in error, pressing the button again will cancel the request. Note: If the regeneration time option is set to "on 0" there is no set delayed regeneration time so "REGEN TODAY" will not activate if "REGEN" button is pressed.

To initiate a manual regeneration immediately, press and hold the "REGEN" button for three seconds. The system will begin to regenerate immediately. The request cannot be cancelled.

Note: For softeners, if brine tank does not contain salt, fill with salt and wait at least two hours before regenerating.

**Set Time of Day**

The user can also set the time of day. Time of day should only need to be set after power outages lasting more than 24 hours, if the battery has been depleted and a power outage occurs or when daylight saving time begins or ends. If a power outage lasting more than 24 hours occurs, the time of day will flash on and off which indicates the time of day should be reset. If a power outage lasts less than 24 hours and the time of day flashes on and off, the time of day should be reset and the non rechargeable battery replaced.

**STEP 1U**

**STEP 1U** – Press SET CLOCK.

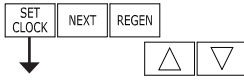

**STEP 2U**

**STEP 2U** - Current Time (hour): Set the hour of the day using ▼ or ▲ buttons. Press NEXT to go to step 3U.

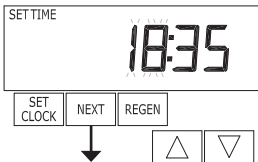

**STEP 3U**

**STEP 3U** - Current Time (minutes): Set the minutes of the day using ▼ or ▲ buttons. Press NEXT to exit Set Clock. Press REGEN to return to previous step.

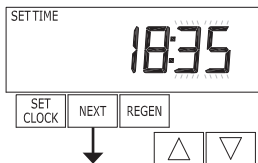

RETURN TO NORMAL MODE

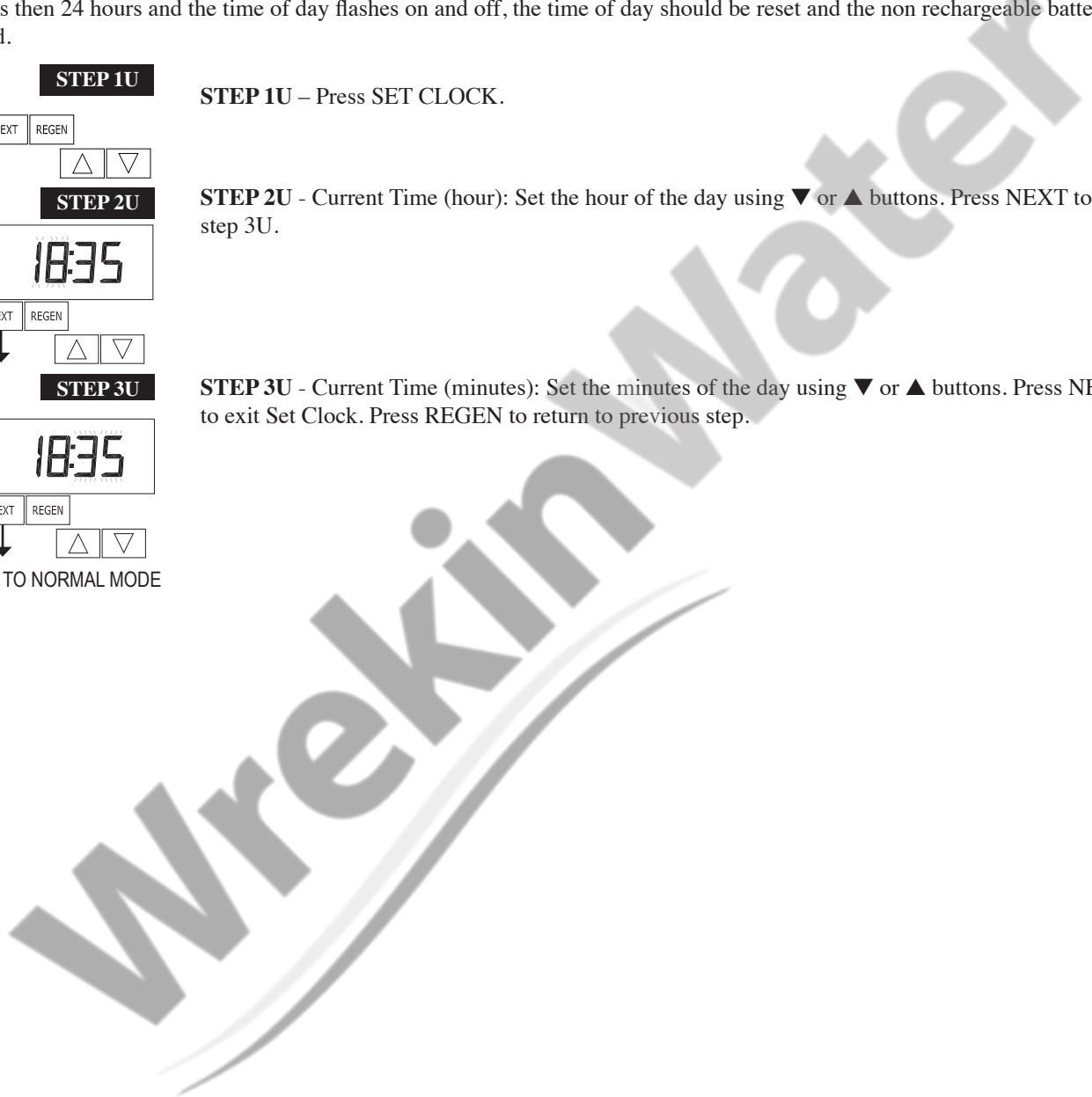

**Salt Remaining or Adding Salt**

If the Low Salt Warning was activated in the last step of OEM Softener System Setup the following screens will be viewed in the User Display.

Note: The salt used per regeneration setting can be set in increments of 0.05 Kg, but the Kg REMAINING screen will round up or down to the closest whole number.

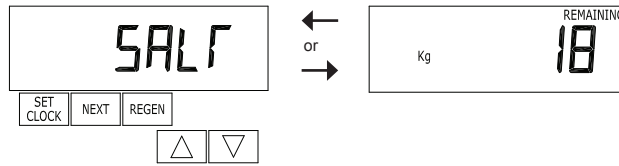

Once the salt remaining has gone below the set point the display will automatically flash Salt Fill.

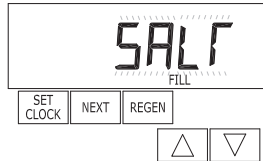

When adding salt to the brine tank (if the salt remaining feature is activated) the following steps must be completed:

**STEP 1US**

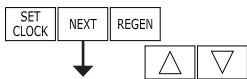

**Step 1US** – Press the NEXT button until SALT appears in the display. It does not matter if the SALT display alternates with the Kg REMAINING display.

**STEP 2US**

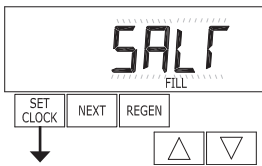

**Step 2US** – Press SET CLOCK.

**STEP 3US**

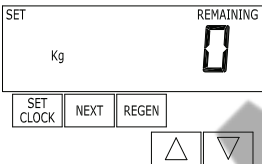

**Step 3US** – Set Kg REMAINING: Use the ▼ or ▲ button to adjust the Kg remaining in the brine tank.

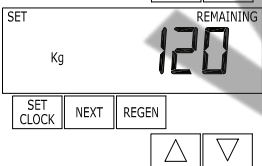

**NOTE:** Estimate the Kg of salt in the brine tank and add it to the amount of salt added to the brine tank. The example at the left would indicate 100 Kg of salt being added to a brine tank that has 20 Kg remaining.

**STEP 4US**

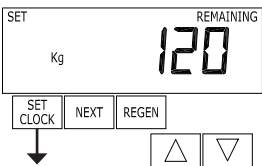

**Step 4US** – Press SET CLOCK to exit Adding Salt.

RETURN TO NORMAL MODE

**Power Loss**

If the power goes out, the system will keep time for 24 hours or until the battery is depleted. If a power outage of more than 24 hours occurs, the time of day will flash on and off which indicates the time of day should be reset. The system will remember the rest. If a power outage lasts less than 24 hours and the time of day flashes on and off, the time of day should be reset and the non rechargeable battery replaced.

**Error Message**

If the word “ERROR” and a number are alternately flashing on the display contact the OEM for help. This indicates that the valve was not able to function properly.

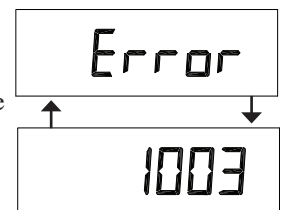



Diagnostics

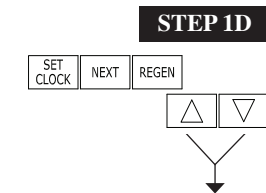

**STEP 1D** – Press ▲ and ▼ simultaneously for three seconds. If screen in step 2D does not appear in 5 seconds the lock on the valve is activated. To unlock press ▲, NEXT, ▼, and SET CLOCK in sequence, then press ▲ and ▼ simultaneously for 3 seconds.

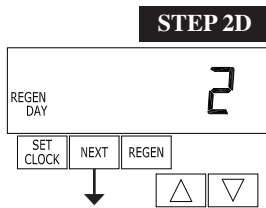

**STEP 2D** – Days, since last regeneration: This display shows the days since the last regeneration occurred. Press the NEXT button to go to Step 3D. Press REGEN to exit Diagnostics.

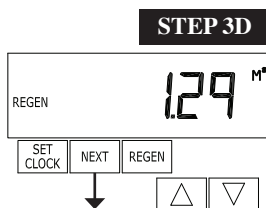

**STEP 3D** – Volume, since last regeneration: This display shows the volume of water that has been treated since the last regeneration. This display will equal zero if a water meter is not installed. Press the NEXT button to go to Step 4D. Press REGEN to return to previous step.

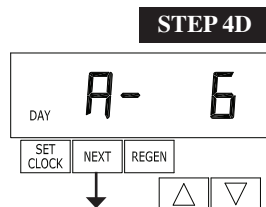

**STEP 4D** – Volume, reserve capacity used for last 7 days: If the valve is set up as a softener, a meter is installed and Set Volume Capacity is set to “Auto,” this display shows 0 day (for today) and flashes the reserve capacity. Pressing the ▲ button will show day 1 (which would be yesterday) and flashes the reserve capacity used. Pressing the ▲ button again will show day 2 (the day before yesterday) and the reserve capacity. Keep pressing the ▲ button to show the capacity for days 3, 4, 5 and 6. The ▼ button can be pressed to move backwards in the day series. Press the NEXT button at any time to go to Step 5D. Press REGEN to return to previous step.

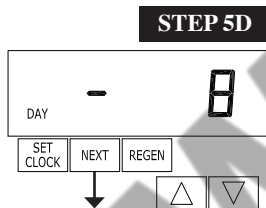

**STEP 5D** - Volume, 63-day usage history: This display shows day 1 (for yesterday) and flashes the volume of water treated yesterday. Pressing the ▲ button will show day 2 (which would be the day before yesterday) and flashes the volume of water treated on that day. Continue to press the ▲ button to show the maximum volume of water treated for the last 63 days. If a regeneration occurred on the day the word “REGEN” will also be displayed. This display will show dashes if a water meter is not installed. Press the NEXT button at any time to go to Step 6D. Press REGEN to return to previous step.

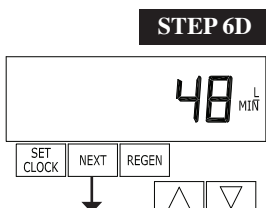

**STEP 6D** – Flow rate, maximum last seven days: The maximum flow rate in liters per minute that occurred in the last seven days will be displayed. This display will equal zero if a water meter is not installed. Press the NEXT button to exit Diagnostics. Press REGEN to return to previous step.

RETURN TO NORMAL MODE

**When desired, all information in Diagnostics may be reset to zero when the valve is installed in a new location. To reset to zero, press NEXT and ▼ buttons simultaneously to go to the Service/OEM 1 Screen. Press ▲ and ▼ simultaneously to reset diagnostic values to zero. Screen will return to User Display.**

Valve History

**STEP 1VH**

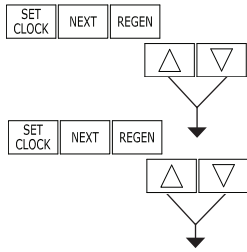

**STEP 1VH** – Press ▲ and ▼ simultaneously for three seconds and release. Then press ▲ and ▼ simultaneously and release. If screen in step 2VH does not appear in 5 seconds the lock on the valve is activated. To unlock press ▼, NEXT, ▲, and SET CLOCK in sequence, then press ▲ and ▼ simultaneously for 3 seconds and release. Then press ▲ and ▼ simultaneously and release.

**STEP 2VH**

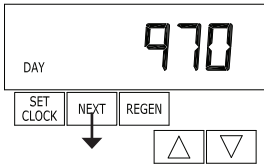

**STEP 2VH<sup>2</sup>** – Days, total since start-up: This display shows the total days since startup. Press the NEXT button to go to Step 3VH. Press REGEN to return to previous step.

**STEP 3VH**

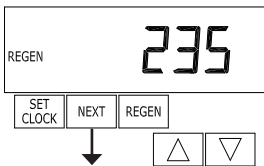

**STEP 3VH** – Regenerations, total number since start-up: This display shows the total number of regenerations that have occurred since startup. Press the NEXT button to go to Step 4VH. Press REGEN to return to previous step.

**STEP 4VH**

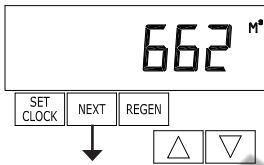

**STEP 4VH** – Volume, total used since start-up: This display shows the total volume of water treated since startup. This display will equal zero if a water meter is not installed. Press the NEXT button to go to Step 5VH. Press REGEN to return to previous step.

**STEP 5VH**

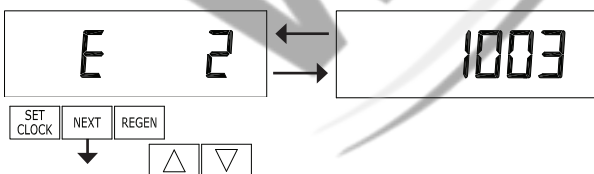

**STEP 5VH** – Error Log: This display shows a history of the last 10 errors generated by the control during operation. Press the ▲ or ▼ buttons to view each recorded error. Press the next button to exit Valve History. Press REGEN to return to previous step.

RETURN TO NORMAL MODE

<sup>2</sup> Values in steps 2VH through 5VH cannot be reset.

## Revision History:

**12/7/07**

**PAGE 6:**

DP Switch and alternating valve operations separated into Steps 3CS and 4CS.

**PAGE 18:**

Added Step 5VH - Error Log.

**2/27/08**

**PAGE 9:**

Added “norES” to Step 8S.

**5/29/08**

Moved common valve drawings to V3435 WS1.5/2L Drawing and Service Manual.

WrekinWater

**Wrekin Water**